

# Wingspan

Freedom to elevate

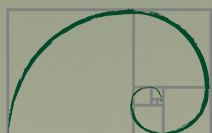

**SPIRALIS**

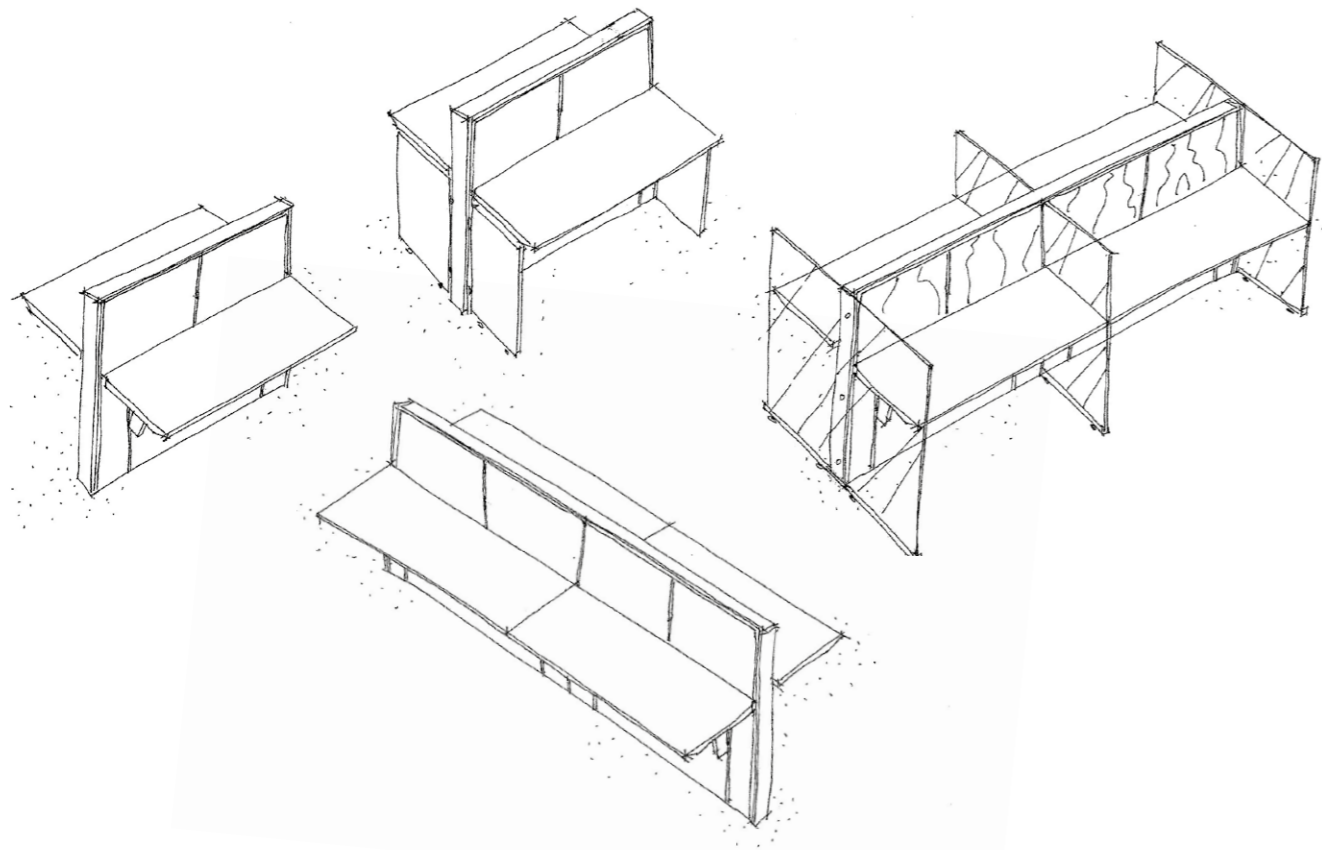

# Cantilever to a new level

Wingspan: Elevating office design to new standards. Our innovative cantilever system brings the future of workspaces to life, offering a floating desk surface that defies convention. With all structural elements and IT equipment smartly concealed, Wingspan delivers a seamless sit-stand experience, free from the clutter of visible legs and cables. Tailored for the modern office, this is not just a piece of furniture—it's a transformative design element that adapts to your space and style with customisable features. Wingspan is the hallmark of minimalist elegance and functional sophistication.



# Take off

A symbol of evolution in the office landscape. This height-adjustable desk stands free from the constraints of traditional legs, offering a sleek silhouette for an uncluttered environment. Its concealed chassis supports a cantilevered top that appears to float, and the mechanism for sit-stand operation is seamlessly integrated, ensuring a clean, cable-free workspace.

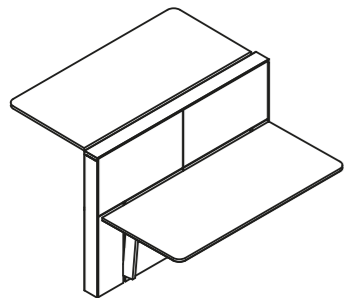
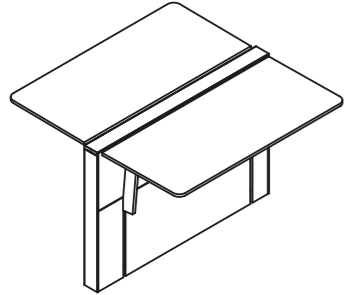
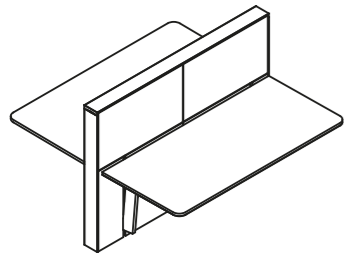

Available in back-to-back or single-sided assembly, with options for slab or raised floor mounting.







# Touch Down

Discover Touch Down, the adaptable height-adjustable desk from the Wingspan series, designed to integrate seamlessly into any office setting. It allows for a variety of free standing stabilising options, ensuring a tailored fit for every space while maintaining the series' signature minimalist elegance. The choice of stabilising elements, including options for slab, raised floor, free standing or mobile designs, allow for a cantilevered floating look.

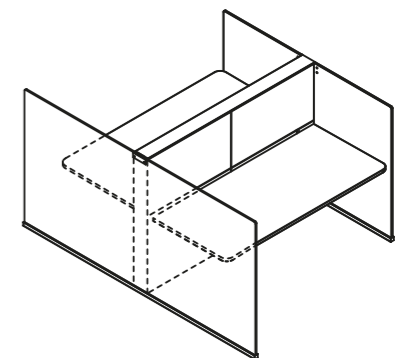
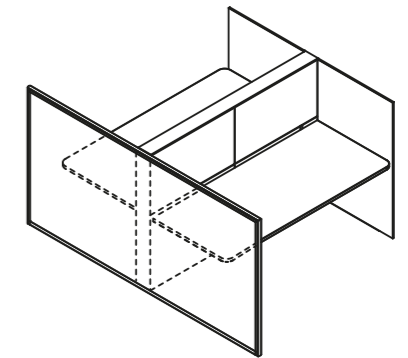

End panel available in frameless or framed glass, with options for fabric finishes.



# Inbound

Forging a path of simplicity and rigidity, Inbound joins the Wingspan series as the quintessential wall fixed cantilevered desk. It embodies the essence of a streamlined workspace, offering a non-adjustable yet sophisticated work surface that effortlessly complements any office setting, fulfilling a variety of functional needs with its simple design.

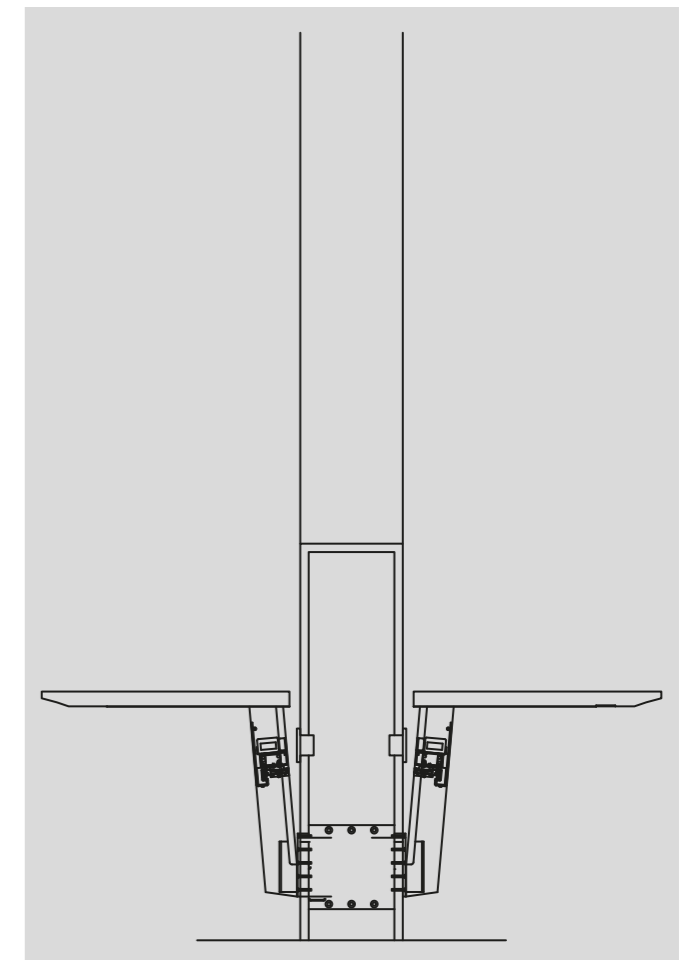
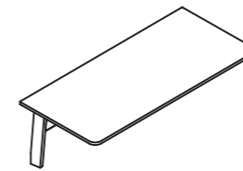

# Wingwall

Wingwall offers a space-efficient, wall-mounted desk solution within the Wingspan series. It achieves an unsupported floating look through an integration of the chassis that attaches directly to the wall. The chassis is equipped with a clip-on skin of decorative or acoustic panels, making it suitable for private offices or compact spaces. Matching other areas of the project.

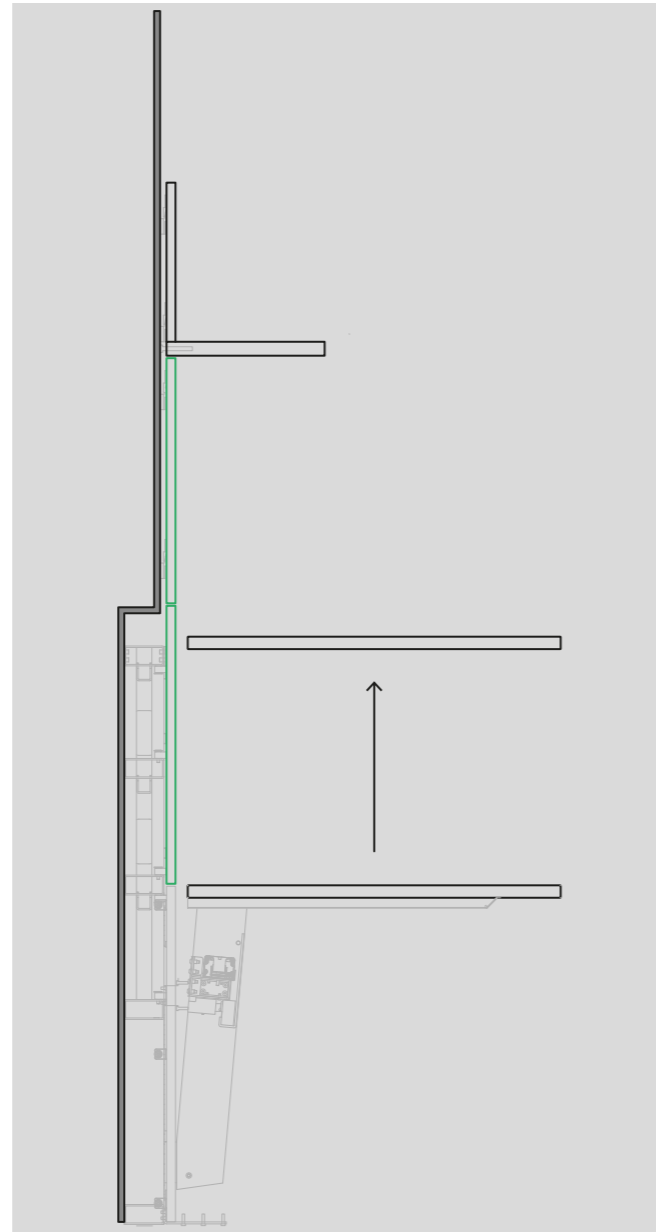
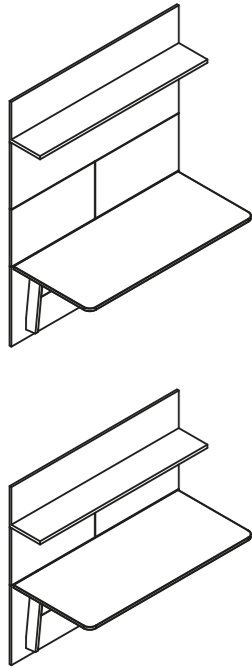

# Glider

Glider propels the Wingspan series to new levels of flexibility, offering a height-adjustable desk equipped with concealed cabling, data ports, and an optional rechargeable battery—all on wheels. Designed for the evolving office landscape, GLIDER ensures that there is always an extra, fully functional workstation available, keeping your workspace dynamic and ready for any scenario.

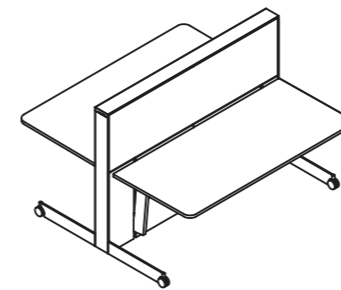



# Solutions

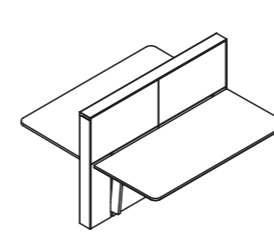

Desk top  
H 68 cm

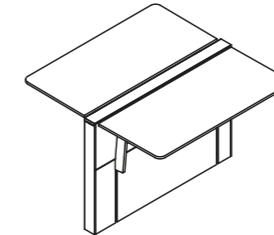

Desk top  
H 118 cm

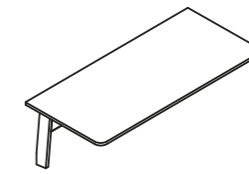

Plan  
Fixed

# Accessories

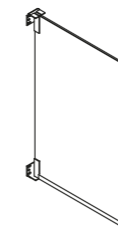

PG1  
Frameless Glass Panel

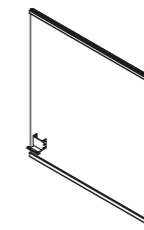

PG1  
Framed Glass Panel

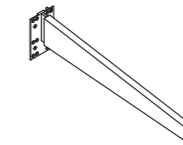

PF  
Stabilising Foot

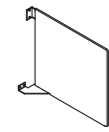

LS  
Stabilising Side

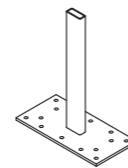

SF  
Fixing structure for chassis  
frame fixed to slab support

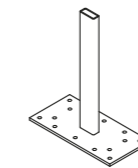

SF1  
Fixing structure for chassis  
frame fixed to raised floor  
support



WS  
Wall Fixing Bracket for  
cantilever arm



WP  
Wall Fixing Kit

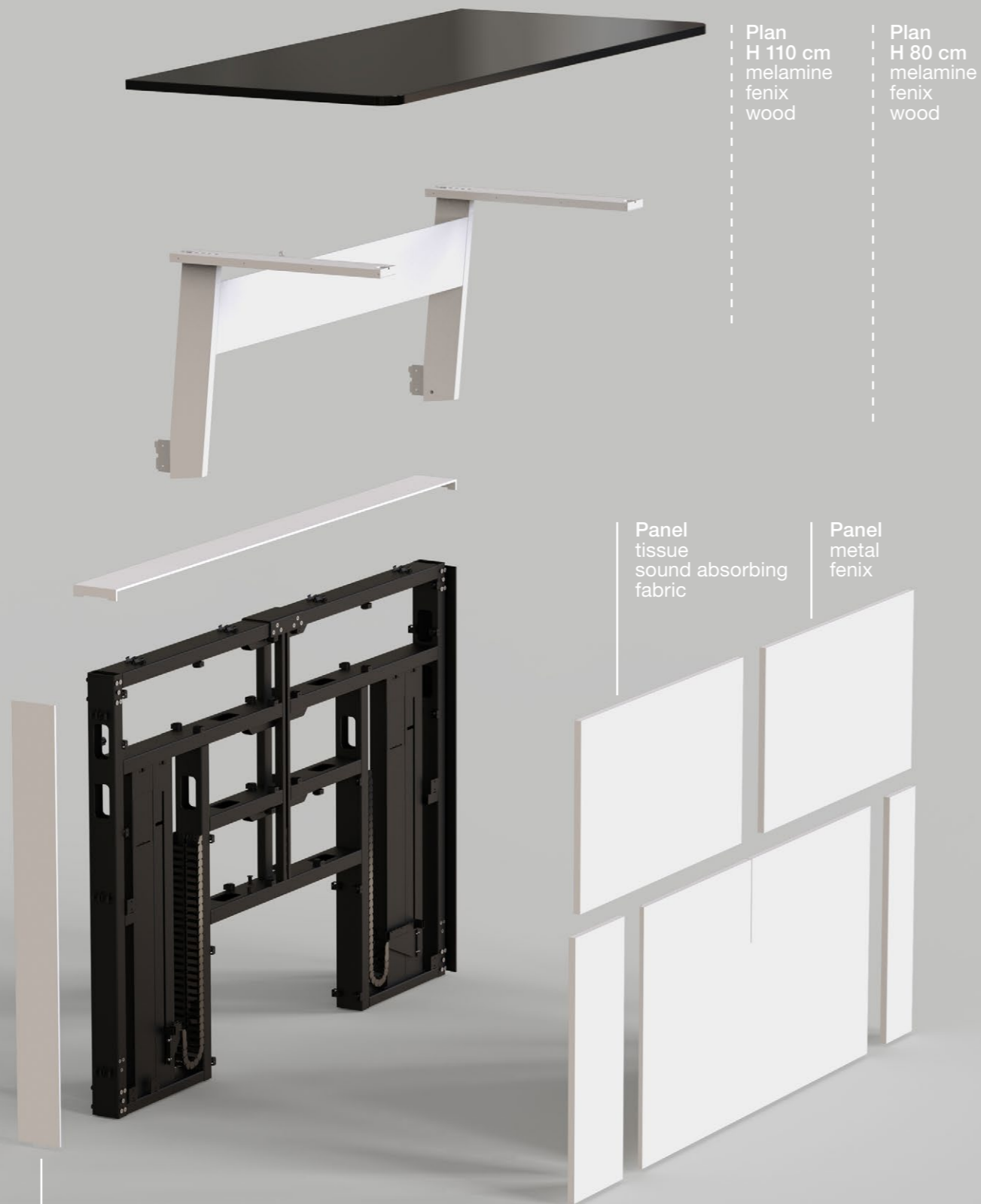

Plan  
H 110 cm  
melamine  
fenix  
wood

Plan  
H 80 cm  
melamine  
fenix  
wood

Panel  
tissue  
sound absorbing  
fabric

Panel  
metal  
fenix

Side



**Concept & design**  
Enrico Sorio

**Product design**  
GabrielPolloni associati

*The images of the products visible in this catalogue are included for information purposes only.*

**Spiralis Europe Ltd.**

7 Wenlock Road  
London N1 7SL  
[spiraliseurope.com](http://spiraliseurope.com)